

# ALLEN & HEATH

# QU-SB



## Getting Started Guide



For Firmware Version V1.9

Publication AP10287



## **Limited One Year Manufacturer's Warranty**

Allen & Heath warrants the Allen & Heath -branded hardware product and accessories contained in the original packaging ("Allen & Heath Product") against defects in materials and workmanship when used in accordance with Allen & Heath's user manuals, technical specifications and other Allen & Heath product published guidelines for a period of ONE (1) YEAR from the date of original purchase by the end-user purchaser ("Warranty Period").

This warranty does not apply to any non-Allen & Heath branded hardware products or any software, even if packaged or sold with Allen & Heath hardware.

Please refer to the licensing agreement accompanying the software for details of your rights with respect to the use of software/firmware ("EULA").

Details of the EULA, warranty policy and other useful information can be found on the Allen & Heath website: [www.allen-heath.com/legal](http://www.allen-heath.com/legal).

Repair or replacement under the terms of the warranty does not provide right to extension or renewal of the warranty period. Repair or direct replacement of the product under the terms of this warranty may be fulfilled with functionally equivalent service exchange units.

This warranty is not transferable. This warranty will be the purchaser's sole and exclusive remedy and neither Allen & Heath nor its approved service centres shall be liable for any incidental or consequential damages or breach of any express or implied warranty of this product.

### **Conditions of Warranty**

The equipment has not been subject to misuse either intended or accidental, neglect, or alteration other than as described in the User Guide or Service Manual, or approved by Allen & Heath.

Any necessary adjustment, alteration or repair has been carried out by an authorised Allen & Heath distributor or agent.

The defective unit is to be returned carriage prepaid to the place of purchase, an authorised Allen & Heath distributor or agent with proof of purchase. Please discuss this with the distributor or the agent before shipping. If the unit is to be repaired in a different country to that of its purchase the repair may take longer than normal, whilst the warranty is confirmed and parts are sourced. Units returned should be packed in the original carton to avoid transit damage.

**DISCLAIMER:** Allen & Heath shall not be liable for the loss of any saved/stored data in products that are either repaired or replaced.

Check with your Allen & Heath distributor or agent for any additional warranty information which may apply. If further assistance is required please contact Allen & Heath Ltd.



Qu Series products comply with the European Electromagnetic Compatibility directive 2014/30/EU and the European Low Voltage directive 2014/35/EU.

Any changes or modifications to the product not approved by Allen & Heath could void the compliance of the product and therefore the user's authority to operate it.

Qu-SB Getting Started Guide AP10287 Issue 2

Copyright © 2016 Allen & Heath. All rights reserved

# **ALLEN & HEATH**

Allen & Heath Limited, Kernick Industrial Estate, Penryn, Cornwall, TR10 9LU, UK

<http://www.allen-heath.com>

## **IMPORTANT - Read these instructions before starting:**

### **Safety instructions**

Before starting, read the Important Safety Instructions sheet supplied with the equipment. Heed all warnings printed on the sheet and on the equipment panels.

### **System operating firmware**

The function of the Qu mixer is determined by the firmware (operating software) that runs it. Check the Allen & Heath website ([www.allen-heath.com](http://www.allen-heath.com)) for the latest version. Firmware can be downloaded and transferred to the mixer via USB key. Read the Release Notes that come with the firmware.

This guide refers to Qu-SB firmware **V1.9**.

### **Software licence agreement**

By using this Allen & Heath product and the software within it you agree to be bound by the terms of the relevant End User Licence Agreement (EULA), a copy of which can be found on the Allen & Heath website ([www.allen-heath.com/legal](http://www.allen-heath.com/legal)). You agree to be bound by the terms of the EULA by installing, copying, or using the software.

### **Further information**

Refer to the Allen & Heath website for further information, knowledgebase and technical support. You can join our Allen & Heath Digital Community to share knowledge and information with other Qu users. Download the Qu Mixer Reference Guide for more information on the Qu setup and mixing functions.

### **General precautions**

- Ensure an adequate service loop and strain relief when plugging in cables. Run cables to avoid a trip hazard.
  - To prevent damage to the equipment, avoid placing heavy objects on the surfaces, scratching the surfaces with sharp objects, or rough handling and vibration.
  - Protect the equipment from damage through liquid or dust contamination. Cover the mixer when it is not being used for a long period.
  - If the equipment has been stored in sub-zero temperatures allow time for it to reach normal operating temperature before use at the venue. Recommended operating temperature for Qu is 5 to 35 degrees Celsius.
  - Avoid using the equipment in extreme heat and direct sunlight. Make sure the mixer ventilation slots are not obstructed and that there is adequate air movement around the equipment.
  - Clean the surface with a soft brush and dry lint-free cloth. Do not use chemicals, abrasives or solvents.
  - It is recommended that servicing is carried out only by an authorised Allen & Heath agent. Contact details for your local distributor can be found on the Allen & Heath website. Allen & Heath do not accept liability for damage caused by maintenance, repair or modification by unauthorised personnel.
-

# 1. Packed contents

**Qu-SB Mixer**



**Getting Started Guide AP10287**



**Safety Sheet**  
AP9240/CL-1

- Read this before starting!



**Mains lead**

- Check this is correct for your territory

## Options and Accessories available

**19" Rack Ears kit**  
Part: QU-SB-RK19

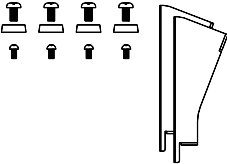

**Qu-SB polyester carry bag**  
Part AP10560



**Remote Audio Racks**  
Provides access to all 32 channels and extra mixes over dSNAKE Cat5 cable digital snake.

**AR2412** 24 Mic/Line in, 12 Line out  
Part: AR2412



**AR84** 8 Mic/Line in, 4 Line out  
Part: AR0804



**AB168** 16 Mic/Line in, 8 Line out  
Remote AudioRack.  
Part: AB1608



**Cat5 cables**  
For use with dSNAKE remote audio

- AH8823 2m (6.6') short patch
- AH9651 20m (66') coil
- AH9981 50m (165') drum
- AH9650 100m (330') drum



**ME Personal Mixing System**

ME-1 Personal Mixer  
ME-U 10-port PoE hub



**Qu-Pad app for iPad\***  
**Qu-You app for iOS\* and Android\*\***  
**Qu-Control app for iOS\***

Qu-Pad



Qu-You



Qu-Control



\*available from the App Store  
\*\*available from the Google Play Store

**REGISTER YOUR PRODUCT** online at: [www.allen-heath.com/register](http://www.allen-heath.com/register)

## 2. Contents

1.	Packed contents .....	4
2.	Contents .....	5
3.	Introduction to Qu-SB .....	6
4.	Installing Qu-SB .....	8
5.	Connector Panel .....	9
6.	Connect and Power Up .....	11
6.1	Set up the Wireless Network .....	11
6.2	Connect dSNAKE (option) .....	12
6.3	Power up the mixer .....	12
6.4	Connect the iPad .....	13
6.5	Connection problems? .....	13
6.6	Get to know the Qu-Pad app .....	14
7.	Qu-Start .....	15
7.1	Set a known starting point .....	15
7.2	Prepare the mixer for your session .....	15
7.3	Save the settings .....	17
7.4	User permissions .....	17
7.5	USB recording and playback .....	18
7.6	A few more functions .....	18
7.7	Network Reset .....	19
7.8	System Hard Reset – Clear everything .....	19
7.9	Firmware Update Procedure .....	20





### 3. Introduction to Qu-SB



Qu-SB is part of the Allen & Heath Qu Series of digital mixers. It is similar to the faderless Qu-Pac but without front panel controls. Qu-SB provides a compact solution for wireless mixing using an iPad. An external Wi-Fi router (wireless access point) is required.

- Band mixer for on-stage live mixing, personal monitoring, live and DAW multitrack recording
  - Corporate event mixing complete with built-in automatic mic mixer (AMM)
  - 32 channel mix engine with 4 internal FX and full processing on all inputs and outputs
  - 16 Mic/Line inputs expandable to 32 via dSNAKE (using optional AudioRack)
  - 37 sources to the mix including 32 Mic/Line, 1 stereo Line input, 4 dedicated FX returns
  - 12 mixes (4 mono, 3 stereo, LR), 4 stereo groups, 2 stereo matrix
  - Local outputs for the 12 mixes, LR and MTX1-2. Access other outputs via dSNAKE
  - Ability to convert groups to mixes (provide up to 4 mono and 7 stereo monitor mixes)
  - Free standing or 19" 4U rack mount (optional rack ear kit)
  - 4 Mute groups, 4 DCA groups
  - Input processing – Preamp, HPF, Gate, PEQ, Compressor, Delay, Ducking
  - Output processing – PEQ, Graphic EQ, Compressor, Delay
  - 100 Scene memories with recall filters, safes and USB data transfer
  - Qu-Drive for stereo and 18-track recording/playback to USB device
  - 32 in, 32 out USB streaming, MIDI DAW control
  - Qu-Pad complete mixing wireless remote app for iPad
  - Qu-You personal monitoring app for iPhone, iPad, iPod Touch, Android
  - Qu-Control customisable app for iOS enabling intuitive wireless control in installed environments.
  - Compatible with the Allen & Heath ME personal mixing system
  - User permissions and login to enable operator access
-

The following diagram shows the available Qu-SB signal flow and processing. A more detailed diagram and further information is available within the Qu Mixer Reference Guide which can be downloaded from the Allen & Heath website.

# Qu-SB

## SIGNAL FLOW

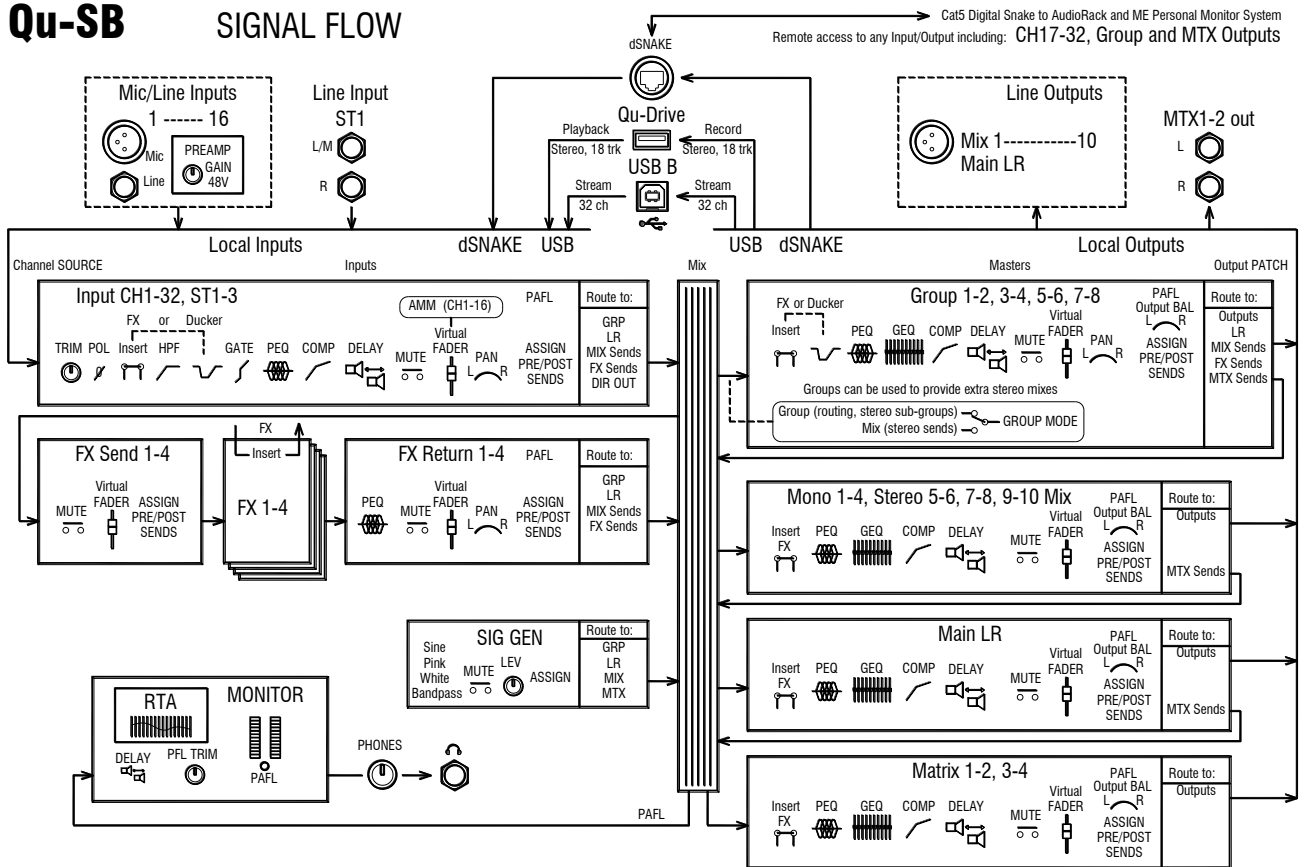

## 4. Installing Qu-SB

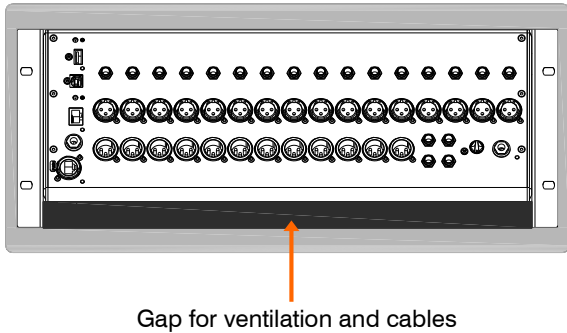
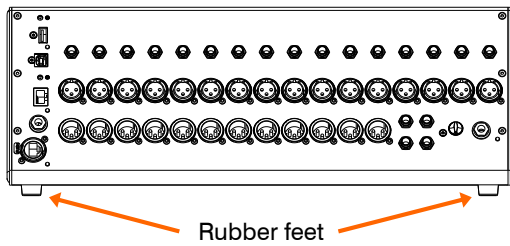

**Free standing** - For operating while on a stage or other flat surface. Make sure the 4 rubber feet are fitted.

**i** - Allow space around the unit for ventilation. Run the cables to avoid a trip hazard.

The mixer should be transported in a purpose designed padded bag or flight case.

**Rack Mounted** - For operating while fitted into a 4U space in a standard 19" equipment rack or flight case. The front panel is angled upwards to allow easier access to plug in the cables. A gap underneath the unit lets you feed cables through from within the rack.

Rack mounting option kit **QU-SB-RK19** is available from Allen & Heath.

**i** - Ensure adequate air flow. Do not block the rear ventilation slots or the gap underneath the front of the unit.

To save space a 'shallow' case with internal depth of 200mm (8") or more is recommended.

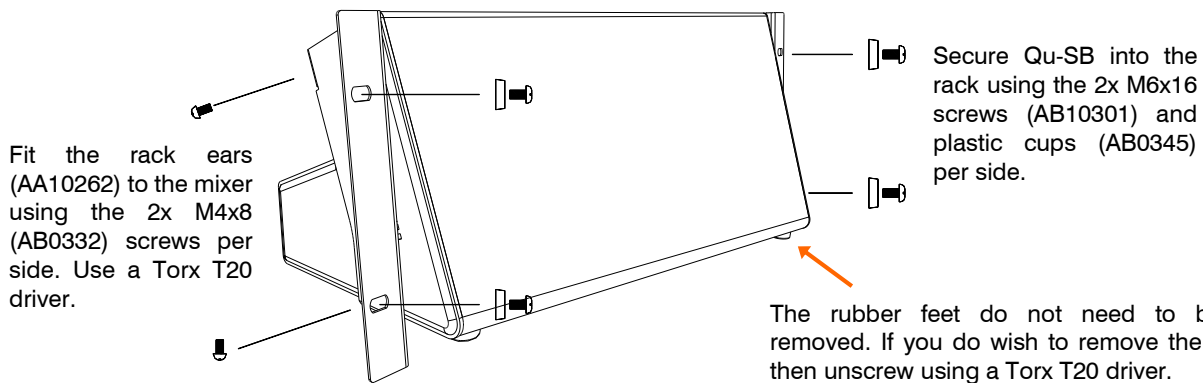

### Dimensions - Shown in millimetres (inches)

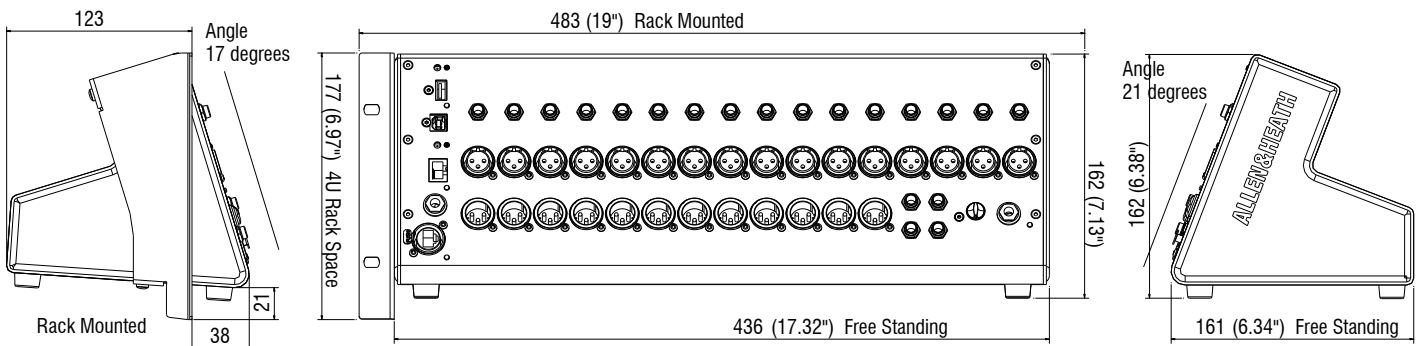



## 5. Connector Panel

This is the front panel of the mixer. It provides all control and audio connections, USB sockets, headphones and reset functions. The only connection provided on the rear panel is the mains power input.

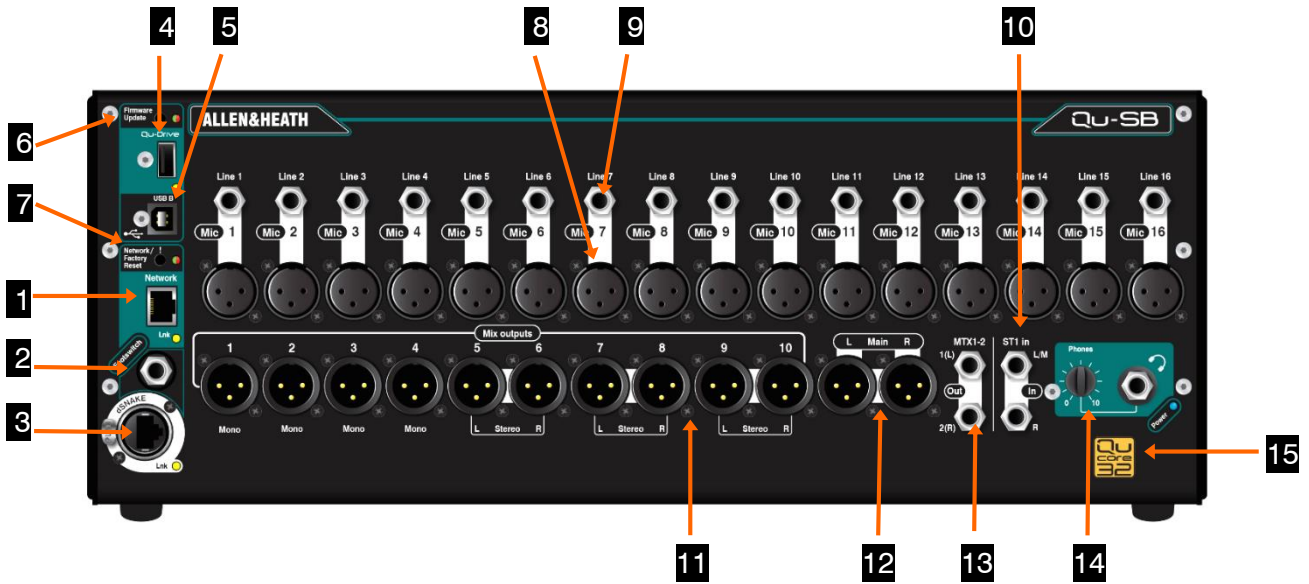

**1 Network Port** – Qu-SB is controlled using an iPad running the Allen & Heath Qu-Pad app. Connect a wireless router (wireless access point) to this port to set up a Wi-Fi network for the iPad to connect to the mixer. This is described in more detail later in this guide.

**2 Footswitch**– 3-Pole (TRS) jack socket to connect a single or dual footswitch controller. Its function is assigned by the user, for example to mute effects between songs or set delay tap tempo.

**3 dSNAKE Port** – Use this port to connect a Cat5 cable ‘digital snake’ to work with remote audio and expand the number of input and output sockets using one of the optional Qu AudioRacks, or connect directly to the Allen & Heath ME personal mixing system letting musicians control their own monitors. Maximum Cat5 cable length is 100m (330’).

**4 Qu-Drive** – Type A USB socket to plug in a USB device such as a key or hard drive to store and transfer mixer data files (scenes, shows, libraries), and to record or playback stereo or multitrack audio WAV files up to 18 tracks. This port is also used to update the mixer firmware via USB key.

**5 USB B** – Type B USB socket to connect the mixer to a computer to stream up to 32 channels of audio to and from a computer, for example to record and playback multi-channel audio using DAW software. Follows the high speed USB 2.0 standard.

Refer to the Allen & Heath web site for information on Windows® and Apple® Mac drivers available for Qu.

**6 Firmware Update** – This recessed switch lets you update the mixer firmware without an iPad connected. The update procedure is described later in this guide.

**7 Network / Factory Reset** – This recessed switch has two functions: To reset the Network port IP address if it has been changed and the mixer does not connect to your router, or to completely reset all mixer parameters to factory default and clear all memories. Reset functions are described later in this guide.

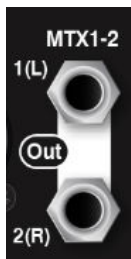

**8 Mic Input** – For plugging in low level sources such as microphones or DI boxes. The preamp uses a balanced XLR socket and has a wide gain range from -5dB to +60dB. 48V can be switched to the XLR for condenser mics and active DI boxes that require phantom power.

Qu-SB provides 32 channels with 16 local input preamps. You can access the additional preamps for the full 32 channels using an optional AudioRack plugged into dSNAKE.

**i** To avoid loud thumps, mute the channel before plugging in cables or equipment while 48V is on.

**9 Line Input** – For plugging in line level signals. The input uses a balanced ¼” TRS (Tip, Ring, Sleeve) jack and has a fixed 10dB pad to handle from low to very high level line signals. For unbalanced sources use a mono jack or link ring to sleeve within the TRS stereo jack. Channels can be linked as odd/even pairs so you can use these inputs to directly plug in stereo sources such as keyboards, samplers and media players.

For high impedance, low level sources such as acoustic instrument pickups use DI boxes plugged into the Mic inputs

**i** Plug into either Mic or Line. Do not plug into both on the same channel.

**10 ST1 Input** – For plugging in a line level stereo source such as a media player for walk-in music. Uses a pair of balanced ¼” TRS jack inputs with the L input switching through the R socket so that you can also work with a mono source by plugging into just the L/M input.

To work with RCA phono connections use jack to RCA converter plugs.

**11 Mix Outputs** – Balanced XLR line level outputs for mono Mix1-4 and stereo Mix5-6 to 9-10. Connect to nominal +4dBu or 0dBu line level equipment. Maximum output is +22dBu.

**12 LR Output** – A pair of balanced XLR line level outputs for the main LR FOH mix.

**13 MTX1-2 Output** – A pair of balanced ¼” TRS jack line level outputs to access stereo Matrix 1-2. You can route any combination of mixes, groups and LR to the matrix, ideal for creating a useful utility mix for stereo recording, broadcast zone sends and more.

Qu-SB provides local outputs for Mix1-10, LR and MTX1-2. You can add more output sockets and access the stereo Group and second matrix outputs using an optional AudioRack plugged into dSNAKE.

**14 Headphone Output** – Lets you monitor any channel or mix signal within the mixer using the PAFL buttons in the Qu-Pad app. Use good quality low impedance stereo headphones. Adjust the level using the Phones control.

**i** To prevent damage to your hearing start with the Phones level turned down and avoid listening to loud volume for extended periods.

**15 Qu-32 Core** – Qu-SB is the smallest model in the Qu range but uses the same 32 channel DSP mix engine as the largest model, the Qu-32. Channels and outputs not available locally at the Qu-SB can be patched from/to sockets on a remote AudioRack via dSNAKE.



## 6. Connect and Power Up

### 6.1 Set up the Wireless Network

Qu-SB is set up and controlled using an iPad. This connects to the mixer via a wireless router plugged into the Network port. This sets up a private Wi-Fi network for the mixer.



**iPad** – Qu-Pad supports models from iPad2 up running iOS7.1 or higher.

**Qu apps** - You can download the Allen & Heath [Qu-Pad](#) mixing control app from the Apple App Store. You can also get the [Qu-You](#) app for musicians personal monitor control for iOS devices including iPad, iPhone and iPod Touch, and also for Android devices. These apps are free and can work with any Qu mixer.

**i** The Qu mixer firmware and app versions must be compatible. For example, V1.8 app will not run with V1.9 firmware. To avoid unexpected version mismatch we recommend you turn off 'auto update' on your iPad. Download the latest Qu mixer firmware from the Allen & Heath web site.

**Number of connections** – Qu supports a maximum of 8x connections including up to 2x iPads running Qu-Pad. The others can be Qu-You.

**Wireless router** - For best performance use a dual band (2.4 and 5GHz) wireless router (wireless access point) with auto channel selection. Position it high up to avoid obstacles such as people and equipment. Avoid locating it behind pillars or walls, near metal beams or on top of loudspeakers.

We recommend that you change the router SSID (name) to identify your network and set a router password (key) for security.

Power up the router. Wait a few minutes for it to establish Wi-Fi broadcast. Go to your wireless device Settings screen, find and connect to the mixer Wi-Fi network.

**i** The iPad remembers the network settings. To prevent a guest engineer using their own iPad on your network without password in future, select your network in their Settings Wi-Fi menu and use the 'Forget this network' function.



**Qu network address** - The mixer must have a TCP/IP (network) address compatible with the router. The Qu default is DHCP enabled which means that the router will automatically allocate a compatible address to the mixer when connected. If the mixer address has been changed and the Qu-Pad app does not connect then you can reset it to this default:

While the mixer is on, use a thin pointed object to press and hold the front panel Network Reset key. The indicator will light and after a few seconds flash to confirm the address has been reset to DHCP.

## 6.2 Connect dSNAKE (option)

If you are using an optional remote AudioRack then connect it with a Cat5 digital snake. Use STP (shielded twisted pair) Cat5e or higher spec cable up to 100m (330') long. Cable with both foil and braided screens provide shielding from interference and are generally more rugged. Stranded core cables are less prone to damage when kinked or repeatedly coiled.



Plug into the AudioRack dSNAKE port. If you are connecting a second AudioRack connect it to the EXPANDER port of the first.

**i** The maximum number of AudioRacks you can connect is two.



If you are using the Allen & Heath ME personal mixing system then connect it to the dSNAKE, EXPANDER or MONITOR (AR2412 only) port. ME-1 mixers can be daisy chained or you can connect individually via the Allen & Heath ME-U PoE hub.

Refer to the ME-1 and ME-U user guides for more information.

You can also use the Qu-You personal monitor app running on iOS or Android devices to let musicians control their own monitors.

## 6.3 Power up the mixer



**i Important** - Before starting, read the **Safety Instructions Sheets** packed with the mixer. These can also be downloaded from the Allen & Heath website.

**i** To avoid loud thumps, do not apply or remove power while the PA speakers are powered.

Always switch the amplifiers on last, and off first.

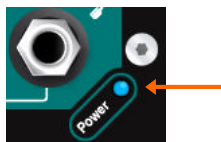

**Switching the mixer on** – Qu-SB does not have a power switch. Plug the provided IEC mains cord into the mixer AC MAINS IN socket. Turn power on at the mains inlet if it is not on already. The mixer takes just a few seconds to boot up. It restores its previous settings and audio.

The front panel **BLUE** Power indicator lights when the mixer is powered.



If you are using an AudioRack or the ME personal mixing system then the yellow dSNAKE Lnk indicator will flash steadily once connection is established.

**Switching the mixer off** – Mute or turn the PA speakers off first. Turn the Qu-SB power off at the mains socket or simply pull out the IEC mains cord at the AC MAINS IN socket.

## 6.4 Connect the iPad

The Qu-SB mixer is controlled using an iPad running the Allen & Heath Qu-Pad app. Choose and set up a wireless router as described previously. Settings are stored in the mixer. Audio will continue to run even if the iPad is disconnected.

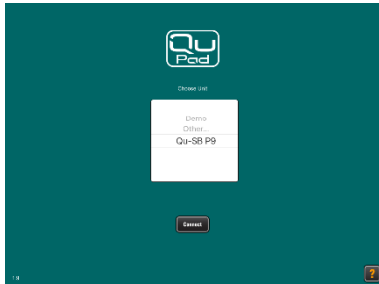
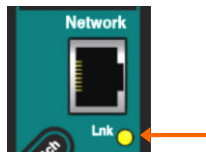

**Connect the Wi-Fi router** – Position and power up your router. Connect one of its LAN ports to the mixer Network port using a Cat5 cable. The yellow Network Lnk indicator will flash once the link is established.

**Connect the iPad to the Qu network** – Go to the iPad **Settings / Wi-Fi** screen and choose your router in the NETWORK list. If it is not in the list give it a few minutes for its broadcast to establish. Check that the iPad shows good signal strength.

**Start the Qu-Pad app** – The app opens on the Connection page. Choose your Qu mixer in the list and touch 'Connect'. Enter the Qu Admin password if one has been set. The app will start in the **Processing** page once logged in.

**i** The app version must be the same as the Qu mixer firmware version. If not, the app will not connect to the mixer.

## 6.5 Connection problems?

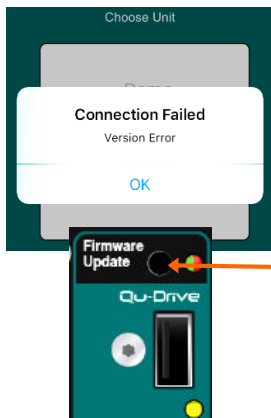
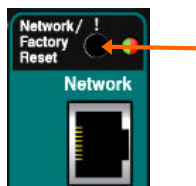

**Qu mixer not shown in Qu-Pad login list** – The mixer and router may have incompatible network addresses. Try a Network reset by pressing and holding the mixer recessed switch.

**Connection Failed - Connection Error** – If you attempt to connect more than the maximum of 8x devices then you will get an error message.

**Connection Failed - Version Error** – If this message appears during Qu-Pad login then the app and mixer firmware are not compatible.

**i** The app version must be the same as the Qu mixer firmware version. If not, the app will not connect to the mixer. The Apple Store will always have the latest version available for free download. We recommend you turn off your iOS device Auto Update function to prevent the app being updated before you have had a chance to update the mixer firmware. Check [www.allen-heath.com](http://www.allen-heath.com) to download the latest Qu firmware.

**Updating Qu-SB firmware** – You can use a USB key and the recessed Firmware Update switch to carry out the update at the mixer. Refer to the instructions later in this guide or on the web site.

**Good Wi-Fi signal but poor connection** – This may be caused by Wi-Fi interference. Try repositioning or rebooting the wireless router.



## 6.6 Get to know the Qu-Pad app



**1 Logout button** – To disconnect and close the app, simply double click the iPad Home button and swipe the app off the screen. If you want to disconnect from the mixer and keep the app open then touch the Logout button.

**2 Page select buttons** – Touch to open the different pages. Qu-Pad opens with the live mixing **Processing** page selected. Other pages are Setup, Home, Scenes and IO Patch.

**3 Scene status** – Displays the names of the Current scene (last recalled since power up) and Next scene (highlighted ready to be recalled).

**4 Fader strips** - The lower pane presents the fader strips for live mixing. Use the tabs on the left to access the channels, FX sends and returns, masters, DCA, Mute groups and SoftKeys. You can also assign up to 3 Custom Layers with any combination of these.

**5 Channel processing** - The upper pane presents the related processing for the selected channel highlighted green on the fader strip. Use the tabs on the left to access its processing parameters. Qu-Pad opens with LR processing selected.

**6 Library** - Touch to open the Library window in the lower pane for the currently selected processing. Factory (fixed) and User (editable) libraries are available.

**7 Mix select buttons** - Touch to select a different mix. The fader strips turn blue and become the sends to that mix. You can work with the mixes, groups and FX in this way. Touch the mix button again or touch LR to return to the main mix.

**8 Mix master strip** - This fader strip becomes the master for the mix selected using the buttons to the right.



Learn more about using Qu-Pad from the Help manual within the app. Open Help from either the **Login** page **?** button or the **Setup** page **Help** tab.

## 7. Qu-Start

This section provides a quick guide to get you started mixing with Qu-SB and Qu-Pad. For more information please refer to the Qu-Pad Help manual and to the Qu Mixer Reference Guide available for download from [www.allen-heath.com/key-series/qu-series](http://www.allen-heath.com/key-series/qu-series).

### 7.1 Set a known starting point

**To completely reset the mixer** you can perform a power up **System Hard Reset**. Only do this if absolutely necessary. This clears all Scenes, User Libraries, User Profiles and passwords and resets all settings to factory default. See section at end of this guide.

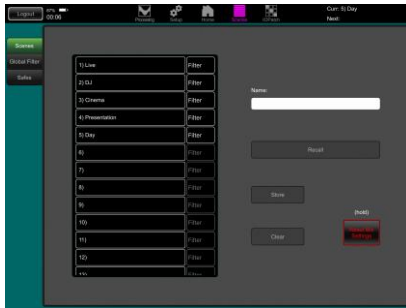

**To zero the board** as a start for setting up a new session or event you could use the **Reset Mix Settings** function on the **Scenes** page. This is a special Scene that resets all current mix parameters to factory default to give you a clear starting point to mix. It does not affect the memories and system settings and preferences.

This reset is not affected by the Global Scene Filter nor channel Safes. It also resets the Global Filter and clears the Safes. Touch and hold the Reset Mix Settings button for 2 seconds and then confirm.

**To set your preferred starting point** you could set up and store your own template **Scene** and keep this on USB device as a backup to load into this and other Qu mixers you may use.

### 7.2 Prepare the mixer for your session



**Choose the channels sources** – You can choose one of 3 sources for each mono and stereo channel – Local socket (rear panel), dSNAKE socket (remote IO), or USB (playback). The reset default is the Local input sources.



To change channel sources use the **Processing** screen Preamp tab Source button. If you are using dSNAKE you can patch any remote socket to any channel. If you are using USB select either Qu-Drive or USB B as the global source.



**Name the channels and masters** – Working from your plot sheet, use the Preamp screen to enter names with up to 6 characters. Touch the name to open the keypad.

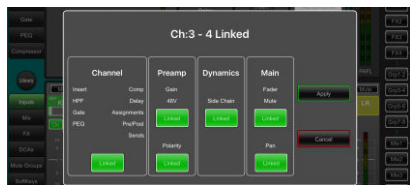

**Link channels for stereo** – You can link odd/even pairs for stereo operation. This links the preamps, processing and levels.

**Use Channel Libraries to get you started** – open the Library to select a Channel Library and recall a typical starting point for common instruments and vocals. Set 'Recall with Preamp' on to include gain and preamp settings.



**Copy / Paste / Reset** – Double tap a channel or master strip to copy or reset its settings. Use the popup menu.

**Check Mix routing and pre/post fade settings** – Mixes 1-10 can be set pre or post fader, channels can be assigned, and the send point within the channel signal path can be chosen.



Touch the right arrow in the **Processing** screen Mix tab to view routing options. Set up a starting point for each mix with all channels on or off, and all sends pre or post.

The reset default is all pre fade, all channels assigned and the sends post-EQ (affected by the EQ but not the compressor). This is ideal for using the mixes as monitor sends.



**Set up the Groups** – These can be configured as audio subgroups or additional stereo mixes, for example when working with many sets of in-ear monitors. Touch the right arrow in the **Processing** screen Grp tab to choose Mix or Group mode. If you are using subgroups to LR, remember to turn off assignments of those channels to the LR mix.

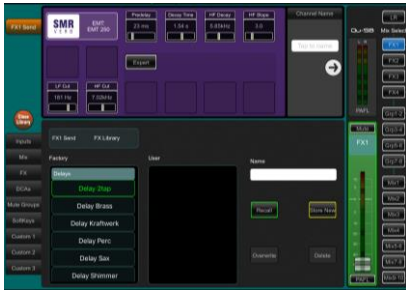

**Set up the Matrix sends** - Use the **Processing** screen Matrix Sends to work with send levels and routing.

**Set up the FX** – Select an FX send or return and use the **Processing** screen to set up the 4 built-in FX units. The reset default sets up two reverbs, a delay and an ADT effect. To change these use the Library button to recall the FX type and preset. Touch the right arrow to change patching. Effects such as reverb and delay use Mix->Return patching. You can also insert FX into a channel or mix.



**Set up Mute and DCA Groups** – Use the **Processing** screen Mute Grp and DCA tabs to name and assign the groups. It can be useful to assign a mute or DCA group to the FX returns providing a quick way to silence or reduce effects between songs.

**Choose the Direct Output application** - channel direct outputs can be used for USB recording, ME-1 personal monitoring, channel Ducker trigger or single channel FX. Set source preferences in the **Processing** screen Preamp page of any input channel. This setting is global and affects all direct outputs.

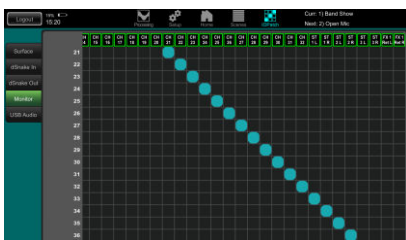

**Patch to optional ME-1 personal monitor systems** - Go to the **I/O Patch** Monitor screen to patch Qu outputs to the 40 ME-1 sends. It is typical to send the input channel direct outputs. The recommended direct out setting is post delay, pre fader, post mute.

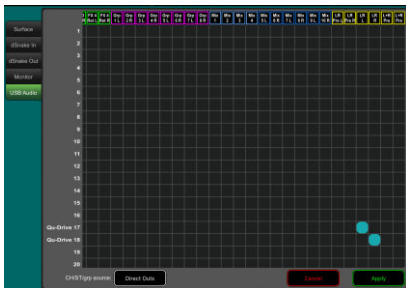

**Patch the USB outputs** – Use the **I/O Patch** USB Audio screen to patch any of the Qu outputs to the **Qu-Drive** multitrack and rear panel **USB B** streaming port. These share the same patch. USB B streaming uses all 32 outputs. Qu-Drive recording is fed from the first 18 outputs, and Qu-Drive stereo recording is fed from outputs 17-18.

Live show multitrack recording typically uses the channel Insert Sends so that live mixing does not affect the recording. You may wish to change this to Direct Outputs for studio recording and other applications.



**Assign the SoftKeys** – The SoftKeys can be user-assigned for various functions such as mute, tap tempo, scenes, Qu-Drive transport and more. Assign these using the **Processing** screen SoftKeys strips. Confirm using the **Apply** button.



**Footswitch** – You can assign control to a single or dual footswitch. Use the **Setup / Control / Footswitch** screen to choose the function and calibrate the operating mode of the switch.

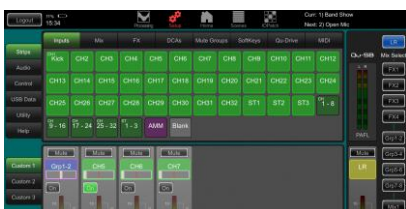

**Assign the Custom Layers** – Use the **Setup** screen Strips page to drag and drop strips to the three available custom strips.

## 7.3 Save the settings

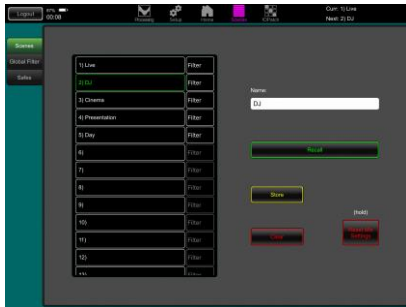

**Scene memories** – Once you have set up the mixer ready for the session, go to the **Scenes** screen to name and store the current mix settings as a scene. You can store up to 100 scenes within the mixer.

For example, you could name and store scenes for each band after you sound check them, as theatre show cues, recording sessions, templates for future shows and so on.



**Global Scene Filter** – This function protects selected parameters of all channels or mix from being overwritten when any scene is recalled. For example, the SoftKey or Custom Layer assignments that you may make after sound check, or the LR mix processing including GEQ which you may change as the audience fills the room. The reset default is Custom Layer and SoftKeys blocked.

**Scene Safes** – This function protects all parameters of a selected channel or mix from being overwritten when a scene is recalled. For example, walk-in music, DJ or presenter. The reset default is no safes set.



**Per Scene Filter** – This is similar to the global filter but protects selected parameters for just one scene recall. Each scene has its own filter. This can be a powerful tool, for example when recalling cues in a theatre show, or effects changes during songs. The reset default is Custom Layer and SoftKeys blocked.

**Show memories** – A Show stores everything including the current mix settings, all 100 scenes, libraries and setup. Shows are not stored within the mixer. They are created directly to a USB drive in the Qu-Drive socket.

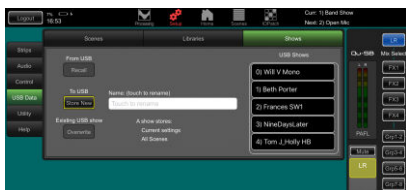

**Archiving and transferring data via USB** – Use a USB device such as a key or drive to archive Qu settings or transfer them between Qu mixers. The memories are compatible with all Qu models. Start by formatting the USB device on the Qu mixer. Use the **Setup / Utility / Qu-Drive** screen Format function.

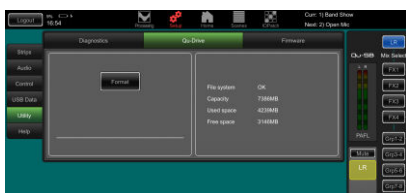

**ⓘ** Formatting will erase any existing data and create a Qu directory on the device. You only need to format the USB device once on the Qu mixer. Do not attempt to edit the Qu data or file names using a computer. Keep the USB device for use with the Qu mixer only.

## 7.4 User permissions

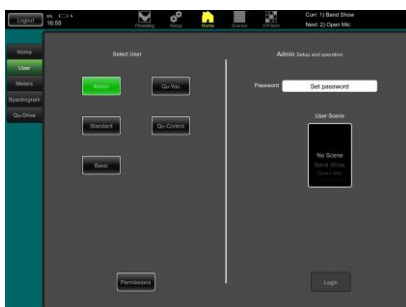

You can protect the system from unauthorised access, and restrict how much control is given to certain operators. Use the **Home / User** page. There are three User Profiles available:

**Admin** – Has access to everything and can configure the mixer, set permissions and passwords.

**Standard** – Can control the live mix but is locked out of system setup functions.

**Basic** – Can control faders and mutes only.

Passwords can be set for each of the three users. These are required at each login and change of user. The Qu-Pad app requires the Admin password if set. Admin can set a separate password for Qu-You and Qu-Control apps. A scene range and login scene can be set for the Standard and Basic users.



## 7.5 USB recording and playback



**USB B Streaming** – Connect an Apple® Mac or Windows® PC computer to the USB B port to stream up to 32 channels of audio in both directions and send MIDI messages.

Download the Allen & Heath DAW Control driver to convert the Qu MIDI Strip messages into HUI or Mackie Control protocol.

Download the Allen & Heath Qu Windows ASIO/WDM driver to stream Audio and MIDI to a PC.

MIDI is transmitted via the USB B port. Set the Qu MIDI channel number using the **Setup / Control / MIDI** screen.

**Qu-Drive recording direct to USB drive** – You can record stereo or 18-track multitrack direct to a USB storage device plugged into the front panel Qu-Drive port.

For more information refer to the 'Understanding Qu-Drive and USB' article in the Qu Knowledgebase at [www.allen-heath.com/support](http://www.allen-heath.com/support).

Use the USB storage device with the Qu mixer only. Do not use it for other applications.

**Format the USB device on the Qu mixer** before recording using the **Setup / Utility / Qu-Drive** screen. This clears the drive and sets up the Qu directory structure.

**Patch the sources to record** using the **I/O Patch / USB Audio** screen. Choose channel sources to be from Insert Sends or Direct Out.

**Record Stereo or Multitrack** - Use the **Home / Qu-Drive** screen. Recording creates WAV files in Qu directories on the USB device. Stereo recording uses the same source as multitrack CH17 and 18.

**Play back Stereo or Multitrack** – Patch USB as the source to the channels using the **Processing** screen Preamp source popup. Select 'Qu-Drive' as the Global USB Source.

**Using Qu-Drive Strips for transport control** – You can use Qu-Drive transport control strips for stereo or multitrack recording and playback, for example, to arm, start and stop recordings while mixing. Use the **Setup** screen Strips page to drag and drop strips to the three available custom strips.

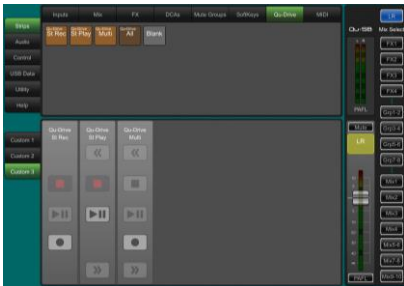
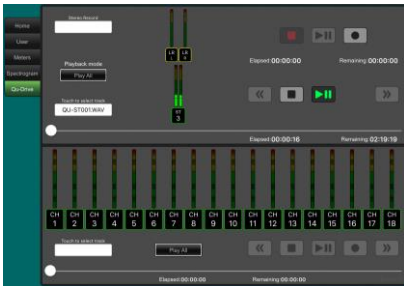

## 7.6 A few more functions



**Signal Generator** – The Qu mixer has a built-in signal generator. Pink noise is an excellent source for testing speakers. It generates equal energy per octave across all frequencies and can be used to check that all speaker drivers are working and to listen for phasing and polarity issues.



**Channel Ducker** – You can insert a ducker into input channels or groups. This lets you use any signal to automatically duck (attenuate) other channels when active. For example, to use a paging mic as a trigger to duck a background music channel when in use.





**Automatic Mic Mixing (AMM)** – This is very useful for speech applications such as conferences and seminars involving several microphones around a table. The Qu AMM can automatically take over the level of these mics to improve clarity and reduce the risk of feedback caused by many open microphones.



**RTA** – The built-in real-time analyser provides a useful display of the frequency response of the currently selected PAFL signal. This can help in finding problem frequencies in a room or while ringing out monitors.

## 7.7 Network Reset

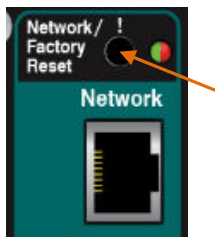

There are two reset functions available using the Qu-SB recessed panel switch above the Network socket.

While the mixer is on, use a thin pointed object to press and hold the front panel Network Reset key.

The Reset indicator will light solid **GREEN** and after a few seconds flash **RED** steadily to warn the reset is in progress. The indicator will flash **GREEN** rapidly to confirm the address has been reset to DHCP.

## 7.8 System Hard Reset – Clear everything



A power-up reset is available if you need to fully reset the Qu mixer settings and its memories. This could be done to clear the system out before sending the mixer to a client, or if you suspect a system problem.

To reset mix parameters before starting a show or sound check (zero the board), use a Scene or the Reset Mix Settings function.

**i** A hard reset sets all current settings to factory default and clears all Scenes, User Libraries, User Permissions, and passwords.

First, check that all amplifiers and powered speakers are turned off.

**To hard reset the Qu mixer** - While the mixer is off, use a thin pointed object to press and hold the front panel Network / Factory Reset key. Plug in the Mains lead. The front panel **BLUE** Power indicator lights when the mixer is powered. The Reset indicator will light solid **RED** and after a few seconds will slowly flash **RED** to warn the reset is in progress.

The indicator will flash **GREEN** rapidly to confirm the System Hard Reset is complete.



## 7.9 Firmware Update Procedure



It may be necessary to update the mixer firmware using a USB device plugged into the Qu-Drive port, without an iPad connected.

Use a USB device of 2GB or larger. The USB device must be formatted FAT32 file system with an Allocation unit size of 32kB.

**Note** Formatting will delete all data on the USB device.

For more information refer to the 'Understanding Qu-Drive and USB' article in the Qu Knowledgebase at [www.allen-heath.com/support](http://www.allen-heath.com/support).

### 1. Download the firmware.

Visit [www.allen-heath.com/downloads](http://www.allen-heath.com/downloads) to find the latest Qu-SB firmware.

The firmware file is packaged in a .zip archive. The file name includes the model and firmware version number, for example QuSBUpdtV1\_90\_xxxx.zip

Always read the Release Notes available on the software download page.

Save the file to your computer.

### 2. Remove any previous Qu Firmware files from your USB device.

It is important to remove previous firmware as the mixer will attempt to load the first version it finds.

The firmware file will be in the root directory of the USB device and has a .QUU extension.

### 3. Extract the .zip folder and place the .QUU file in the root directory of your USB device.

### 4. Plug the USB device into the Qu-Drive port.

### 5. Use a thin pointed object to press and hold the Firmware Update Button to run the Firmware Update procedure.

The update procedure will run a file check during the Firmware Update indicator will either:

- Flash **GREEN** to confirm the file on the USB device is newer than the firmware installed.
- Flash **RED** if the file is older than the firmware installed.
- Light solid **RED** if there is an issue with the USB device or if the file is not valid.

### Release the Firmware Update Button within 3 seconds to cancel the update procedure.

After 3 seconds the Firmware Update indicator will slowly flash **RED**

The update is now in progress. You may release the Firmware Update button at this point.

The indicator will flash **GREEN** to confirm the update is complete.

**ⓘ Important! Do not remove mains power or USB device from the mixer until the update is fully completed.**

Once complete the mixer will reboot automatically.

The yellow Qu-Drive USB activity indicator will flash briefly to show the device is mounted.

The Firmware Update procedure and system reboot is now fully complete.

To verify the update has been successful, press and hold the Firmware Update button.

The indicator will light solid **GREEN** to show the installed firmware matches the file on the USB device.

**Release the Firmware Update button before 3 seconds to avoid starting the update procedure again!**

Please refer to the Qu Mixer Reference Guide for more information on these and other Qu hardware and operational functions.